

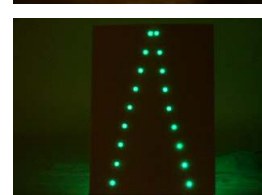

RGB Controller

K8088

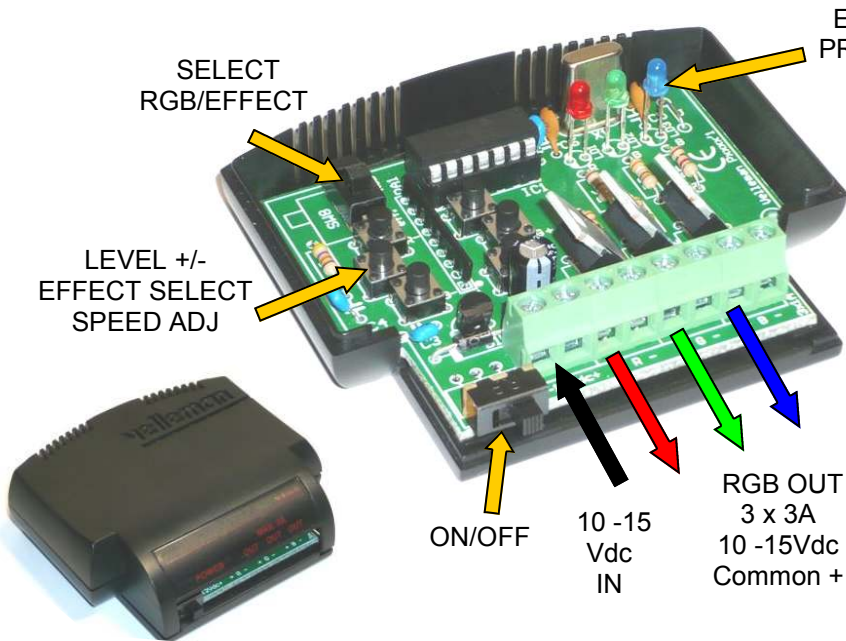

Suited for both incandescent bulbs and LEDs

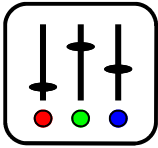

Up-down level adjust for each output

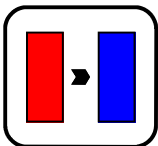

Hard transition effects
Running light, Strobo, Colour loops, etc...

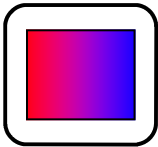

Smooth fade effects
Colour change, flame effect, random colours, slow off etc...

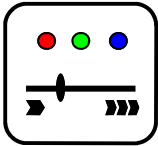

Wide-range effect speed adjust



Hi power MOSFET outputs

3 x 3A

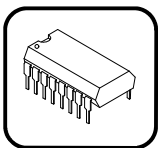

Memory for last selected effect & speed

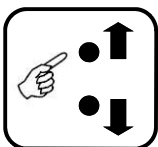

Easy up/down effect select

[Demo pictures using our LDB1-HS3027AC RGB LED strip](#)

Technical:

- 256 intensity levels/ch.
- Voltage output: same as input voltage
- Current output possible (on-board resistor needed)
- Suited for common anode RGB strips
- LED PWM freq: 82Hz
- Power supply: 10 - 15Vdc / 9A max.
- Dimensions: approx 80x70x23mm